

# Surface Mount Transient Voltage Suppressors (TVS)

**SMCJ Series 5.0 To 440 V 1500W**

## Description

The SMCJ series is designed specifically to protect sensitive electronic equipment from voltage transients induced by lightning and other transient voltage events.

## Features

- ◆ For surface mounted applications in order to optimize board space
- ◆ Low leakage
- ◆ Uni and Bidirectional unit
- ◆ Glass passivated junction
- ◆ Low inductance
- ◆ Excellent clamping capability
- ◆ 1500W Peak power capability at 10 × 1000μs waveform Repetition rate (duty cycle):0.01%
- ◆ Fast response time: typically less than 1.0ps from 0 Volts to  $V_{BR}$  min
- ◆ Typical  $I_R$  less than 5μA above 12V.
- ◆ High Temperature soldering: 260°C/40 seconds at terminals
- ◆ Typical maximum temperature coefficient  $\Delta V_{BR} = 0.1\% \times V_{BR}@25^\circ\text{C} \times \Delta T$
- ◆ Plastic package has Underwriters Laboratory Flammability 94V-0
- ◆ Matte tin lead-free Plated
- ◆ Halogen free and RoHS compliant
- ◆ Typical failure mode is short from over-specified voltage or current
- ◆ Whisker test is conducted based on JEDEC JESD201A per its table 4a and 4c
- ◆ IEC-61000-4-2 ESD 15kV(Air), 8kV (Contact)
- ◆ ESD protection of data lines in accordance with IEC 61000-4-2 (IEC801-2)
- ◆ EFT protection of data lines in accordance with IEC 61000-4-4 (IEC801-4)

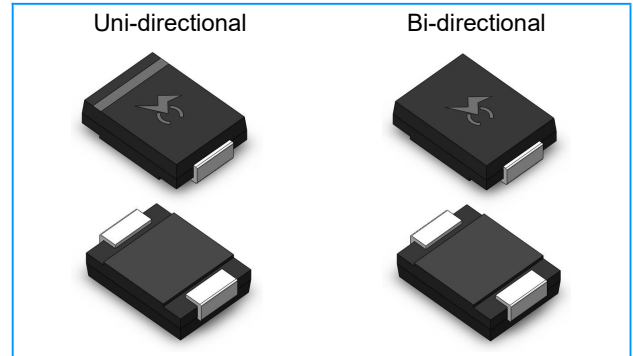

## Functional Diagram

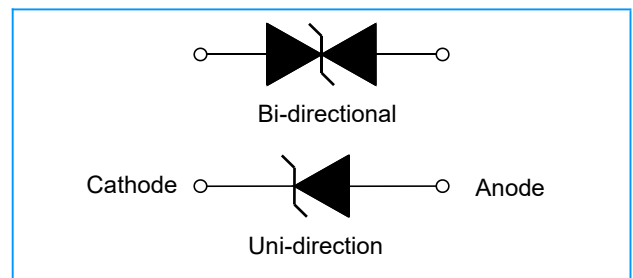

## Agency Approvals

AGENCY	AGENCY FILE NUMBER
	E341027

## Applications

TVS devices are ideal for the protection of I/O interfaces,  $V_{CC}$  bus and other vulnerable circuits used in Telecom, Computer, Industrial and Consumer electronic applications.

## Maximum Ratings ( $T_A=25^\circ\text{C}$ unless otherwise noted)

Parameter	Symbol	Value	Unit
Peak Pulse Power Dissipation with a 10/1000μs waveform (Fig.1)(Note 1), (Note 2)	$P_{PPM}$	1500	Watts
Peak Pulse Current with a 10/1000μs waveform.(Note1, Fig.3)	$I_{PP}$	See Next Table	Amps
Power Dissipation on Infinite Heat Sink at $T_L=75^\circ\text{C}$	$P_{M(AV)}$	6.5	Watt
Peak Forward Surge Current, 8.3ms Single Half Sine Wave (Note 3)	$I_{FSM}$	200	Amps
Maximum Instantaneous Forward Voltage at 25A for Unidirectional Only (Note 4)	$V_F$	3.5/5.0	Voltage
Operating junction and Storage Temperature Range.	$T_J, T_{STG}$	-55 to +150	$^\circ\text{C}$

### Notes:

1. Non-repetitive current pulse, per Fig. 3 and derated above  $T_A = 25^\circ\text{C}$  per Fig. 2.
2. Mounted on 5.0mm x 5.0mm (0.03mm thick) Copper Pads to each terminal.
3. 8.3ms single half sine-wave, or equivalent square wave, Duty cycle = 4 pulses per minutes maximum.
4.  $V_F < 3.5\text{V}$  for  $V_{BR} < 200\text{V}$  and  $V_F < 6.5\text{V}$  for  $V_{BR} > 201\text{V}$ .

## Surface Mount Transient Voltage Suppressors (TVS)

**SMCJ Series 5.0 To 440 V 1500W**

Electrical Characteristics ( $T_A=25^{\circ}\text{C}$  unless otherwise noted)

Part Number		Marking		Reverse Stand-Off Voltage $V_{RWM}$ (V)	Breakdown Voltage $V_{BR}$ (V) @ $I_T$		Test Current $I_T$ (mA)	Maximum Clamping Voltage $V_C$ @ $I_{PP}$ (V)	Maximum Peak Pulse Current $I_{PP}$ (A)	Maximum Reverse Leakage $I_R$ @ $V_{RWM}$ ( $\mu\text{A}$ )
Uni	Bi	Uni	Bi		MIN	MAX				
SMCJ5.0A	SMCJ5.0CA	GDE	BDE	5.0	6.40	7.00	10	9.2	163.04	1000
SMCJ6.0A	SMCJ6.0CA	GDG	BDG	6.0	6.67	7.37	10	10.3	145.63	1000
SMCJ6.5A	SMCJ6.5CA	GDK	BDK	6.5	7.22	7.98	10	11.2	133.93	500
SMCJ7.0A	SMCJ7.0CA	GDM	BDM	7.0	7.78	8.60	10	12.0	125.00	200
SMCJ7.5A	SMCJ7.5CA	GDP	BDP	7.5	8.33	9.21	1	12.9	116.28	100
SMCJ8.0A	SMCJ8.0CA	GDR	BDR	8.0	8.89	9.83	1	13.6	110.29	50
SMCJ8.5A	SMCJ8.5CA	GDT	BDT	8.5	9.44	10.40	1	14.4	104.17	20
SMCJ9.0A	SMCJ9.0CA	GDV	BDV	9.0	10.00	11.10	1	15.4	97.40	10
SMCJ10A	SMCJ10CA	GDX	BDX	10.0	11.10	12.30	1	17.0	88.24	5
SMCJ11A	SMCJ11CA	GDZ	BDZ	11.0	12.20	13.50	1	18.2	82.42	5
SMCJ12A	SMCJ12CA	GEE	BEE	12.0	13.30	14.70	1	19.9	75.38	5
SMCJ13A	SMCJ13CA	GEG	BEG	13.0	14.40	15.90	1	21.5	69.77	5
SMCJ14A	SMCJ14CA	GEK	BEK	14.0	15.60	17.20	1	23.2	64.66	5
SMCJ15A	SMCJ15CA	GEM	BEM	15.0	16.70	18.50	1	24.4	61.48	5
SMCJ16A	SMCJ16CA	GEP	BEP	16.0	17.80	19.70	1	26.0	57.69	5
SMCJ17A	SMCJ17CA	GER	BER	17.0	18.90	20.90	1	27.6	54.35	5
SMCJ18A	SMCJ18CA	GET	BET	18.0	20.00	22.10	1	29.2	51.37	5
SMCJ19A	SMCJ19CA	GEB	BEB	19.0	21.10	23.30	1	30.8	48.73	5
SMCJ20A	SMCJ20CA	GEV	BEV	20.0	22.20	24.50	1	32.4	46.30	5
SMCJ22A	SMCJ22CA	GEX	BEX	22.0	24.40	26.90	1	35.5	42.25	5
SMCJ24A	SMCJ24CA	GEZ	BEZ	24.0	26.70	29.50	1	38.9	38.56	5
SMCJ26A	SMCJ26CA	GFE	BFE	26.0	28.90	31.90	1	42.1	35.63	5
SMCJ28A	SMCJ28CA	GFG	BFG	28.0	31.10	34.40	1	45.4	33.04	5
SMCJ30A	SMCJ30CA	GFK	BFK	30.0	33.30	36.80	1	48.4	30.99	5
SMCJ33A	SMCJ33CA	GFM	BFM	33.0	36.70	40.60	1	53.3	28.14	5
SMCJ36A	SMCJ36CA	GFP	BFP	36.0	40.00	44.20	1	58.1	25.82	5
SMCJ40A	SMCJ40CA	GFR	BFR	40.0	44.40	49.10	1	64.5	23.26	5
SMCJ43A	SMCJ43CA	GFT	BFT	43.0	47.80	52.80	1	69.4	21.61	5

## Surface Mount Transient Voltage Suppressors (TVS)

SMCJ Series 5.0 To 440 V 1500W

Electrical Characteristics ( $T_A=25^\circ\text{C}$  unless otherwise noted) (Continue)

Part Number		Marking		Reverse Stand-Off Voltage $V_{RWM}$ (V)	Breakdown Voltage $V_{BR}$ (V) @ $I_T$		Test Current $I_T$ (mA)	Maximum Clamping Voltage $V_C$ @ $I_{PP}$ (V)	Maximum Peak Pulse Current $I_{PP}$ (A)	Maximum Reverse Leakage $I_R$ @ $V_{RWM}$ ( $\mu\text{A}$ )
Uni	Bi	Uni	Bi		MIN	MAX				
SMCJ45A	SMCJ45CA	GFV	BFV	45.0	50.00	55.30	1	72.7	20.63	5
SMCJ48A	SMCJ48CA	GFX	BFX	48.0	53.30	58.90	1	77.4	19.38	5
SMCJ51A	SMCJ51CA	GFZ	BFZ	51.0	56.70	62.70	1	82.4	18.20	5
SMCJ54A	SMCJ54CA	GGE	BGE	54.0	60.00	66.30	1	87.1	17.22	5
SMCJ58A	SMCJ58CA	GGG	BGG	58.0	64.40	71.20	1	93.6	16.03	5
SMCJ60A	SMCJ60CA	G GK	B GK	60.0	66.70	73.70	1	96.8	15.50	5
SMCJ64A	SMCJ64CA	G GM	B GM	64.0	71.10	78.60	1	103.0	14.56	5
SMCJ70A	SMCJ70CA	G GP	B GP	70.0	77.80	86.00	1	113.0	13.27	5
SMCJ75A	SMCJ75CA	G GR	B GR	75.0	83.30	92.10	1	121.0	12.40	5
SMCJ78A	SMCJ78CA	G GT	B GT	78.0	86.70	95.80	1	126.0	11.90	5
SMCJ80A	SMCJ80CA	G GB	B GB	80.0	88.80	97.60	1	129.6	11.57	5
SMCJ85A	SMCJ85CA	G GV	B GV	85.0	94.40	104.00	1	137.0	10.95	5
SMCJ90A	SMCJ90CA	G GX	B GX	90.0	100.00	111.00	1	146.0	10.27	5
SMCJ100A	SMCJ100CA	G GZ	B GZ	100.0	111.00	123.00	1	162.0	9.26	5
SMCJ110A	SMCJ110CA	G HE	B HE	110.0	122.00	135.00	1	177.0	8.47	5
SMCJ120A	SMCJ120CA	G HG	B HG	120.0	133.00	147.00	1	193.0	7.77	5
SMCJ130A	SMCJ130CA	G HK	B HK	130.0	144.00	159.00	1	209.0	7.18	5
SMCJ140A	SMCJ140CA	G HB	B HB	140.0	155.00	171.00	1	226.8	6.61	5
SMCJ150A	SMCJ150CA	G HM	B HM	150.0	167.00	185.00	1	243.0	6.17	5
SMCJ160A	SMCJ160CA	G HP	B HP	160.0	178.00	197.00	1	259.0	5.79	5
SMCJ170A	SMCJ170CA	G HR	B HR	170.0	189.00	209.00	1	275.0	5.45	5
SMCJ180A	SMCJ180CA	G HT	B HT	180.0	201.00	220.00	1	291.6	5.14	5
SMCJ190A	SMCJ190CA	G HV	B HV	190.0	211.00	232.00	1	307.8	4.87	5
SMCJ200A	SMCJ200CA	G HW	B HW	200.0	224.00	247.00	1	324.0	4.60	5
SMCJ220A	SMCJ220CA	G HX	B HX	220.0	246.00	272.00	1	356.0	4.20	5
SMCJ250A	SMCJ250CA	G HZ	B HZ	250.0	279.00	309.00	1	405.0	3.70	5
SMCJ300A	SMCJ300CA	G JE	B JE	300.0	335.00	371.00	1	486.0	3.10	5
SMCJ350A	SMCJ350CA	G JG	B JG	350.0	391.00	432.00	1	567.0	2.60	5
SMCJ400A	SMCJ400CA	G JK	B JK	400.0	447.00	494.00	1	648.0	2.30	5
SMCJ440A	SMCJ440CA	G JM	B JM	440.0	492.00	543.00	1	713.0	2.10	5

**Note:**

1. Suffix 'A' denotes 5% tolerance device.
2. Add suffix 'CA' after part number to specify Bi-directional devices.
3. For Bi-Directional devices having  $V_R$  of 10 volts and under, the  $I_R$  limit is doubl.

# Surface Mount Transient Voltage Suppressors (TVS)

**SMCJ Series 5.0 To 440 V 1500W**

Ratings and Characteristic Curves ( $T_A=25^\circ\text{C}$  unless otherwise noted)

**Figure 1 - Peak Pulse Power Rating Curve**

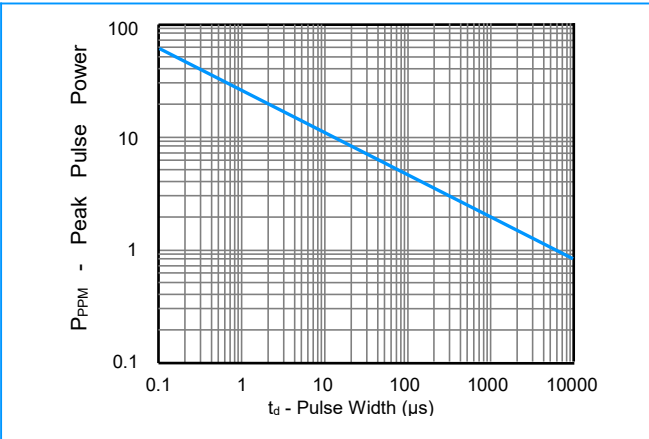

**Figure 2 - Pulse Derating Curve**

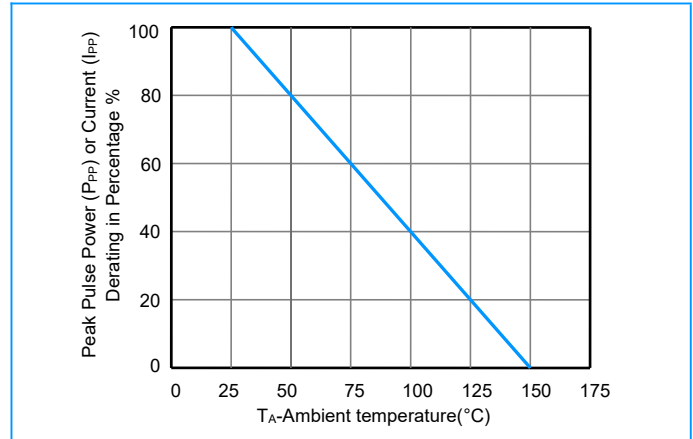

**Figure 3 - Pulse Waveform**

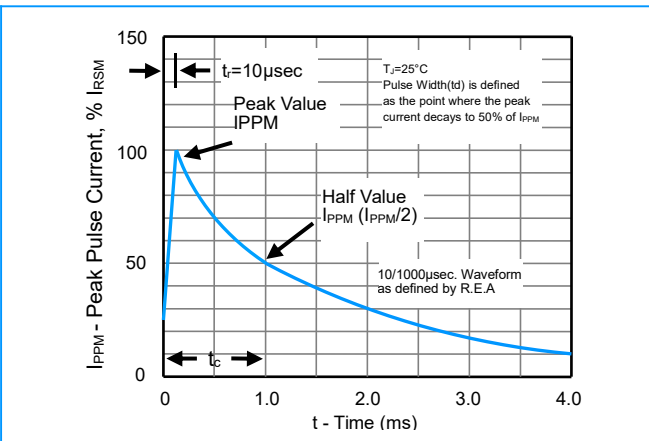

**Figure 4 - Typical Junction Capacitance**

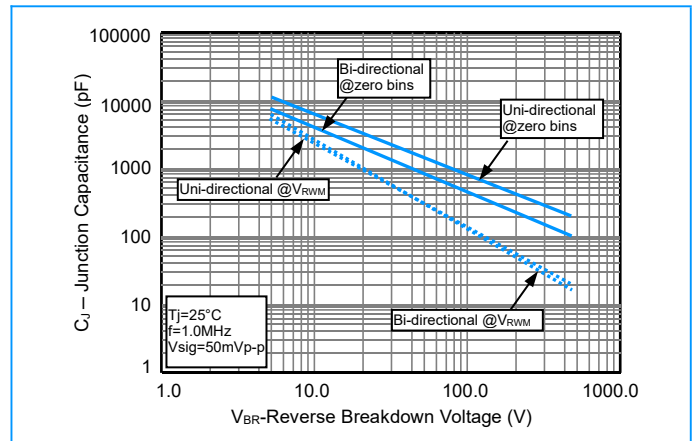

**Figure 5 - Steady State Power Derating Curve**

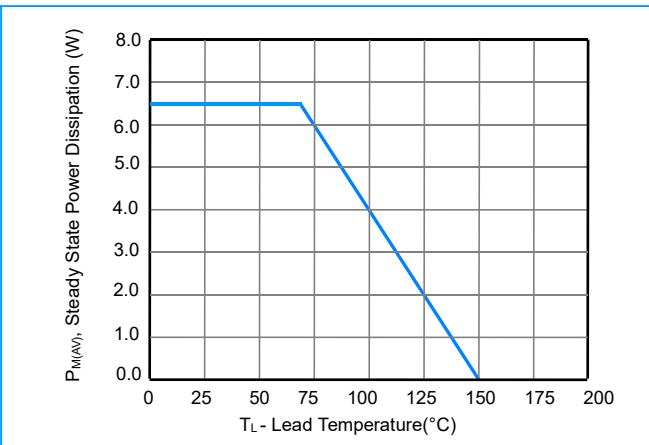

**Figure 6 - Maximum Non-Repetitive Surge Current**

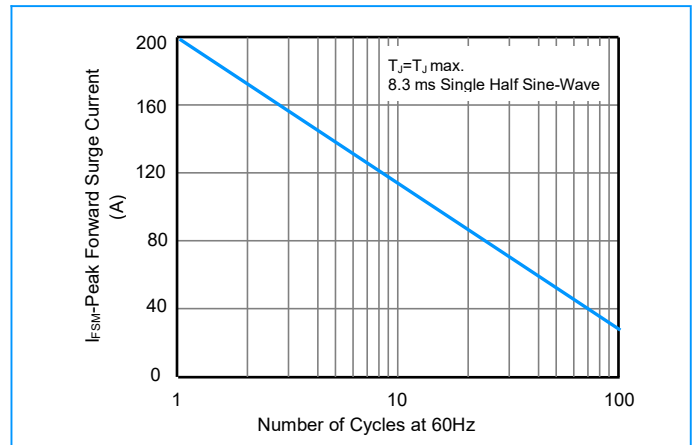

# Surface Mount Transient Voltage Suppressors (TVS)

**SMCJ Series 5.0 To 440 V 1500W**

## I-V Curve Characteristics

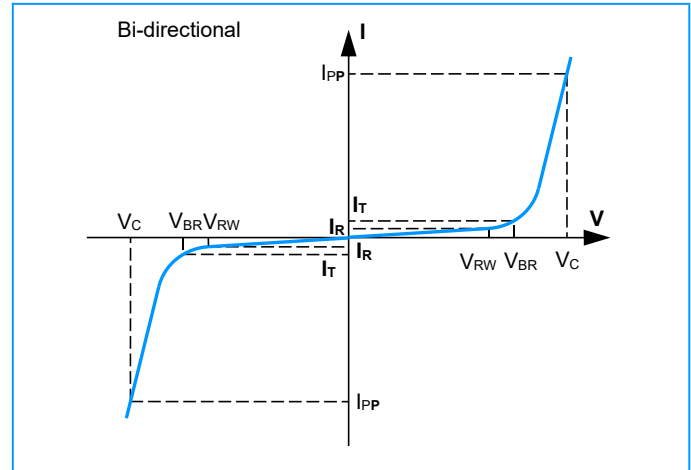
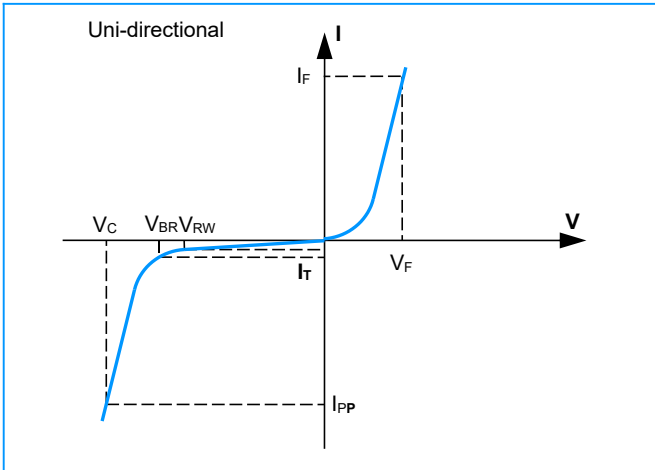

## Physical Specifications

<b>Weight</b>	0.007 ounce, 0.21 gram
<b>Case</b>	JEDEC DO-214AB Molded Plastic over glass passivated junction
<b>Polarity</b>	Color band denotes cathode except Bipolar
<b>Terminal</b>	Matte Tin-plated leads, Solderable per JESD22-B102D

## Environmental Specifications

<b>Temperature Cycle</b>	JESD22-A104
<b>Pressure Cooker</b>	JESD22-A102
<b>High Temp. Storage</b>	JESD22-A103
<b>HTRB</b>	JESD22-A108
<b>Thermal Shock</b>	JESD22-A106

## Soldering Parameters

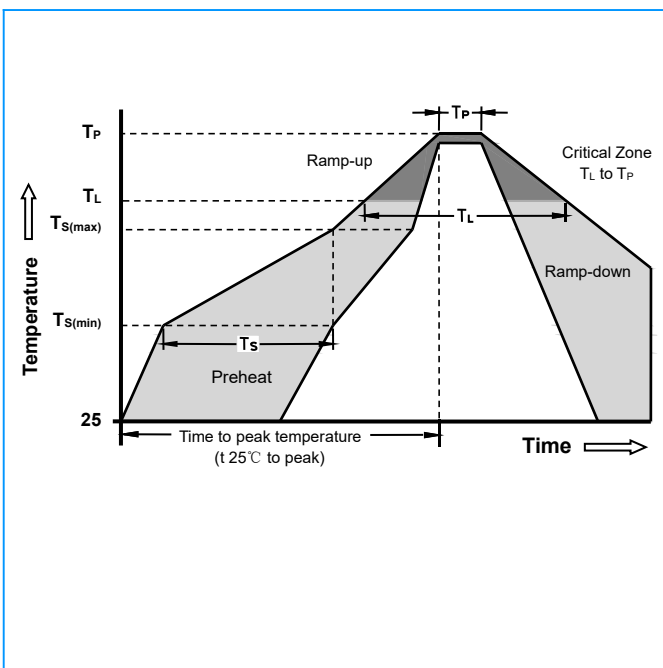

<b>Reflow Condition</b>		Lead-free assembly
<b>Pre Heat</b>	-Temperature Min ( $T_{S(min)}$ )	150°C
	-Temperature Max ( $T_{S(max)}$ )	200°C
	- Time (min to max) ( $T_S$ )	60 -180 Seconds
<b>Average ramp up rate ( Liquidus Temp <math>T_L</math>) to peak</b>		3°C/second max
<b><math>T_{S(max)}</math> to <math>T_L</math> - Ramp-up Rate</b>		3°C/second max
<b>Reflow</b>	- Temperature ( $T_L$ ) (Liquidus)	217°C
	- Time (min to max) ( $T_L$ )	60 -150 Seconds
<b>Peak Temperature (<math>T_P</math>)</b>		260 +0/-5°C
<b>Time within 5°C of actual peak Temperature (<math>t_p</math>)</b>		20 -40 Seconds
<b>Ramp-down Rate</b>		6°C/second max
<b>Time 25°C to peak Temperature (<math>T_P</math>)</b>		8 minutes Max
<b>Do not exceed</b>		280°C

# Surface Mount Transient Voltage Suppressors (TVS)

SMCJ Series 5.0 To 440 V 1500W

## Dimensions

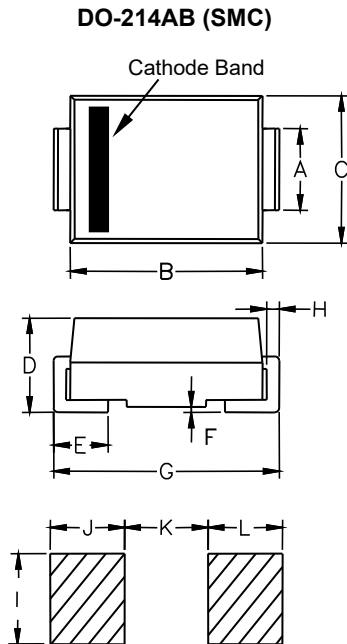

Dimensions	Inches		Millimeters	
	Min	Max	Min	Max
A	0.108	0.126	2.750	3.200
B	0.260	0.280	6.520	7.110
C	0.217	0.244	5.520	6.220
D	0.080	0.112	2.050	2.850
E	0.030	0.060	0.750	1.520
F	-	0.008	-	0.203
G	0.305	0.320	7.640	8.130
H	0.006	0.012	0.150	0.310
I	0.121	-	3.070	-
J	0.068	-	1.715	-
K	-	0.185	-	4.690
L	0.068	-	1.715	-

## Part Numbering

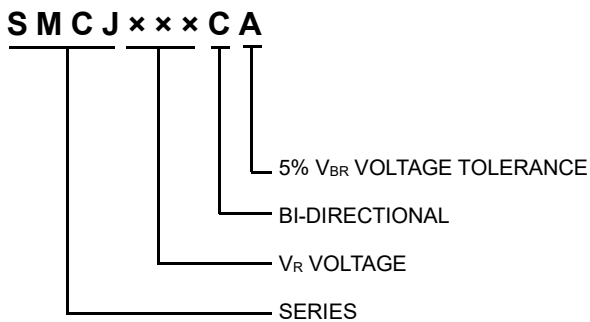

## Part Marking

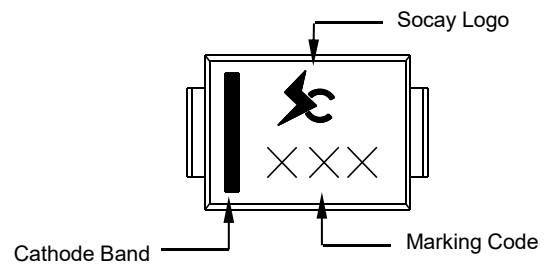

# Surface Mount Transient Voltage Suppressors (TVS)

**SMCJ Series 5.0 To 440 V 1500W**

## Packaging

Part Number	Component Package	Reel (pcs)	Per Carton (pcs)	Packaging Option	Reel Diameters (mm)
SMCJXXXXX	DO-214AB (SMC)	3000	48000	Tape & Reel - 20mm/13"tape	330.0

## Tape and Reel Specifications

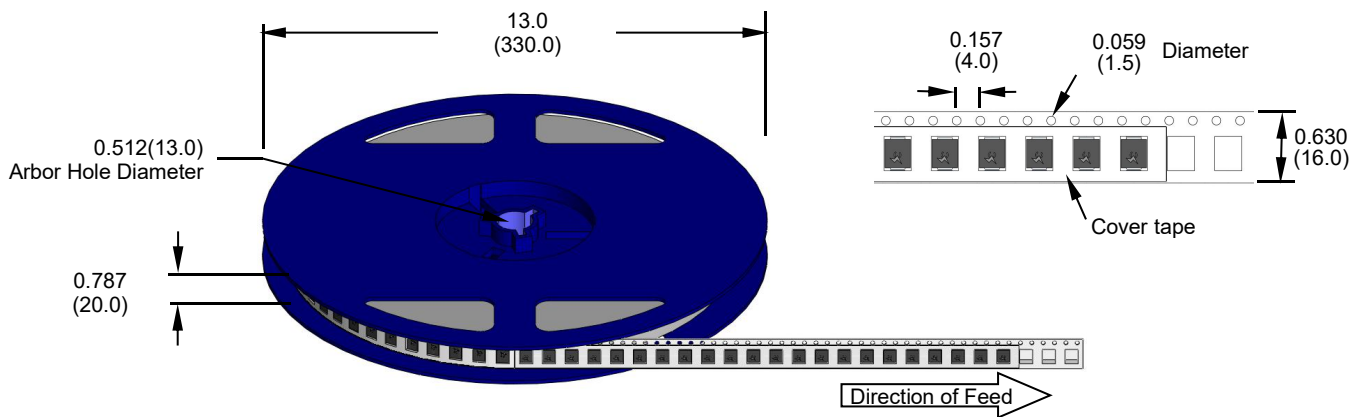

Dimensions are in inches (and millimeters)