

# Axial Lead Transient Voltage Suppressors (TVS)

**20KPA Series    20 To 300 V    20000W**

## Description

The 20KPA series is designed specifically to protect sensitive electronic equipment from voltage transients induced by lightning and other transient voltage events.

## Features

- ◆ Glass passivated chip junction in P600 Package
- ◆ Low leakage
- ◆ Uni and Bidirectional unit
- ◆ Excellent clamping capability
- ◆ 20000W Peak power capability at 10 × 1000µs waveform Repetition rate (duty cycle):0.01%
- ◆ Fast response time: typically less than 1.0ps from 0 Volts to V<sub>BR</sub> min
- ◆ Typical I<sub>R</sub> less than 2µA above 50V.
- ◆ High Temperature soldering: 260°C/40 seconds at terminals
- ◆ Typical maximum temperature coefficient  $\Delta V_{BR} = 0.1\% \times V_{BR@25^{\circ}C} \times \Delta T$
- ◆ Plastic package has Underwriters Laboratory Flammability 94V-0
- ◆ Matte tin lead-free Plated
- ◆ Halogen free and RoHS compliant
- ◆ Typical failure mode is short from over-specified voltage or current
- ◆ Whisker test is conducted based on JEDEC JESD201A per its table 4a and 4c
- ◆ IEC-61000-4-2 ESD 15kV(Air), 8kV (Contact)
- ◆ ESD protection of data lines in accordance with IEC 61000-4-2 (IEC801-2)
- ◆ EFT protection of data lines in accordance with IEC 61000-4-4 (IEC801-4)

Uni-directional

Bi-directional

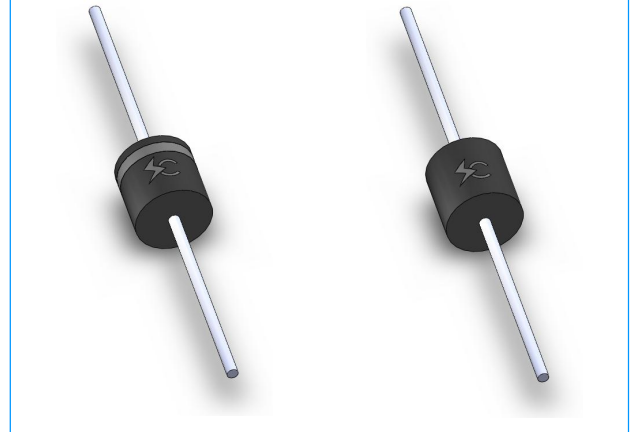

## Functional Diagram

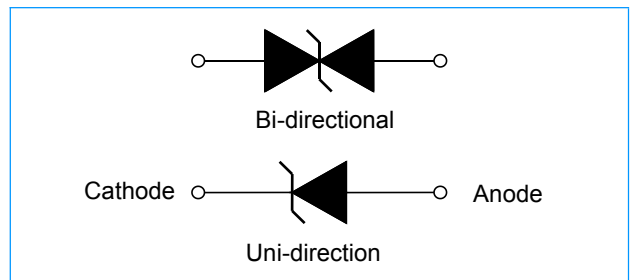

## Applications

TVS devices are ideal for the protection of I/O interfaces, V<sub>CC</sub> bus and other vulnerable circuits used in Telecom, Computer, Industrial and Consumer electronic applications.

## Maximum Ratings (T<sub>A</sub>=25°C unless otherwise noted)

Parameter	Symbol	Value	Unit
Peak Pulse Power Dissipation with a 10/1000µs waveform (Fig.1)(Note 1), (Note 2)	P <sub>PPM</sub>	15000	Watts
Peak Pulse Current with a 10/1000µs waveform.(Note1, Fig.3)	I <sub>PP</sub>	See Next Table	Amps
Power Dissipation on Infinite Heat Sink at T <sub>L</sub> =75°C	P <sub>M(AV)</sub>	8.0	Watt
Peak Forward Surge Current, 8.3ms Single Half Sine Wave (Note 3)	I <sub>FSM</sub>	500	Amps
Operating junction and Storage Temperature Range.	T <sub>J</sub> , T <sub>STG</sub>	-55 to +150	°C

## Notes:

1. Non-repetitive current pulse, per Fig. 3 and derated above T<sub>A</sub> = 25°C per Fig. 2.
2. Mounted on 5.0mm x 5.0mm (0.03mm thick) Copper Pads to each terminal.
3. 8.3ms single half sine-wave, or equivalent square wave, Duty cycle = 4 pulses per minutes maximum.
4. V<sub>F</sub> < 3.5V for V<sub>BR</sub> < 200V and V<sub>F</sub> < 6.5V for V<sub>BR</sub> > 201V.

## Axial Lead Transient Voltage Suppressors (TVS)

**20KPA Series    20 To 300 V    20000W**

Part Number		Reverse Stand-Off Voltage $V_{RWM}$ (V)	Breakdown Voltage $V_{BR}$ (V) @ $I_T$	Test Current $I_T$ (mA)	Maximum Clamping Voltage $V_C$ @ $I_{PP}$ (V)	Maximum Peak Pulse Current $I_{PP}$ (A)	Maximum Reverse Leakage $I_R$ @ $V_{RWM}$ ( $\mu$ A)
Uni	Bi		MIN				
20KPA20A	20KPA20CA	20	22.34	50	36.8	548.9	5000
20KPA24A	20KPA24CA	24	26.81	50	41.2	490.3	5000
20KPA26A	20KPA26CA	26	29.04	50	22.7	451.9	2000
20KPA28A	20KPA28CA	28	31.28	50	48.0	420.8	1000
20KPA30A	20KPA30CA	30	33.51	5	51.5	392.2	250
20KPA32A	20KPA32CA	32	35.74	5	54.3	372.0	150
20KPA34A	20KPA34CA	34	38.00	5	57.5	351.3	50
20KPA36A	20KPA36CA	36	40.20	5	61.5	328.5	20
20KPA40A	20KPA40CA	40	44.70	5	67.8	297.9	15
20KPA44A	20KPA44CA	44	49.10	5	72.7	277.9	2
20KPA48A	20KPA48CA	48	53.60	5	79.4	254.4	2
20KPA52A	20KPA52CA	52	58.10	5	85.8	235.4	2
20KPA56A	20KPA56CA	56	62.60	5	92.6	218.1	2
20KPA60A	20KPA60CA	60	67.00	5	97.6	207.0	2
20KPA64A	20KPA64CA	64	71.50	5	104.0	194.2	2
20KPA68A	20KPA68CA	68	76.00	5	110.0	183.6	2
20KPA72A	20KPA72CA	72	80.40	5	116.0	174.1	2
20KPA80A	20KPA80A	80	89.40	5	130.0	155.4	2
20KPA88A	20KPA88CA	88	98.30	5	142.0	142.3	2
20KPA96A	20KPA96CA	96	107.20	5	155.0	130.3	2
20KPA104A	20KPA104CA	104	116.20	5	168.0	120.2	2
20KPA112A	20KPA112CA	112	125.10	5	182.0	111.0	2
20KPA120A	20KPA120CA	120	134.00	5	194.0	104.1	2
20KPA132A	20KPA132CA	132	147.40	5	213.0	94.8	2
20KPA144A	20KPA144CA	144	160.80	5	232.0	87.1	2
20KPA160A	20KPA160CA	160	178.70	5	258.0	78.3	2
20KPA172A	20KPA172CA	172	192.10	5	277.0	72.9	2
20KPA180A	20KPA180CA	180	201.10	5	291.0	69.4	2
20KPA192A	20KPA192CA	192	214.50	5	309.0	65.4	2
20KPA204A	20KPA204CA	204	227.90	5	329.0	61.4	2
20KPA216A	20KPA216CA	216	241.30	5	348.0	58.0	2
20KPA232A	20KPA232CA	232	159.10	5	374.0	54.0	2
20KPA240A	20KPA240CA	240	268.10	5	387.0	52.2	2
20KPA256A	20KPA256CA	256	286.00	5	412.0	49.0	2
20KPA280A	20KPA280CA	280	312.80	5	451.0	44.8	2
20KPA300A	20KPA300CA	300	335.10	5	483.0	41.8	2

**Note:**

- For Bi-Directional devices having  $V_R$  of 40 volts and under, the  $I_R$  limit is double

# Axial Lead Transient Voltage Suppressors (TVS)

20KPA Series 20 To 300 V 20000W

Ratings and Characteristic Curves ( $T_A=25^\circ\text{C}$  unless otherwise noted)

**Figure 1 - Peak Pulse Power Rating Curve**

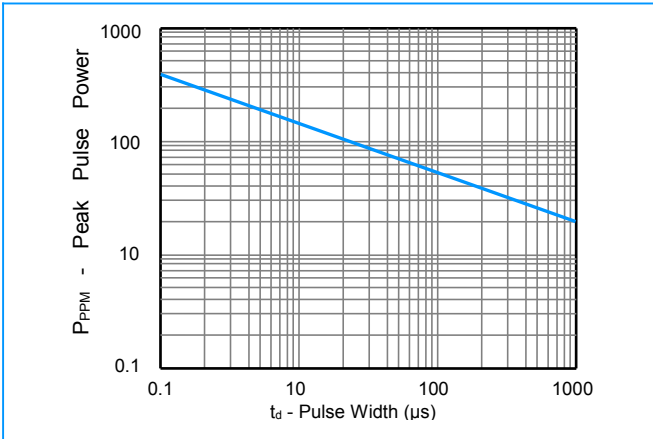

**Figure 2 - Pulse Derating Curve**

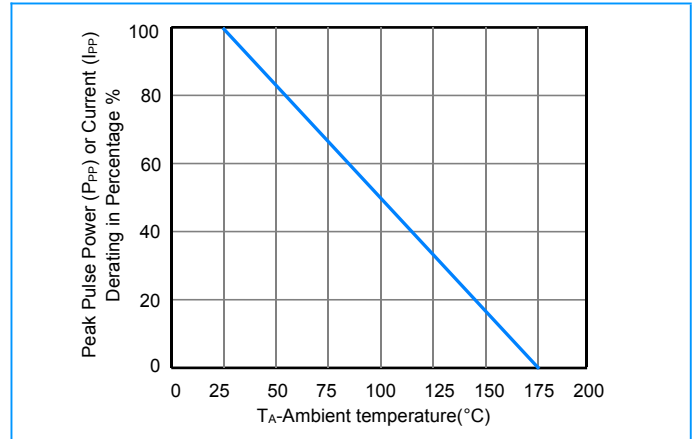

**Figure 3 - Pulse Waveform**

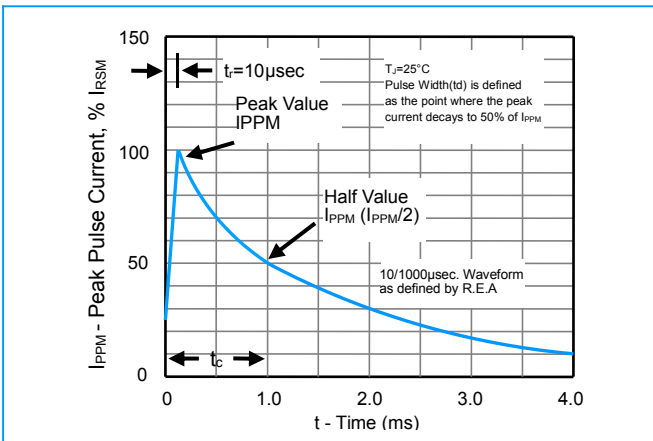

**Figure 4 - Typical Junction Capacitance**

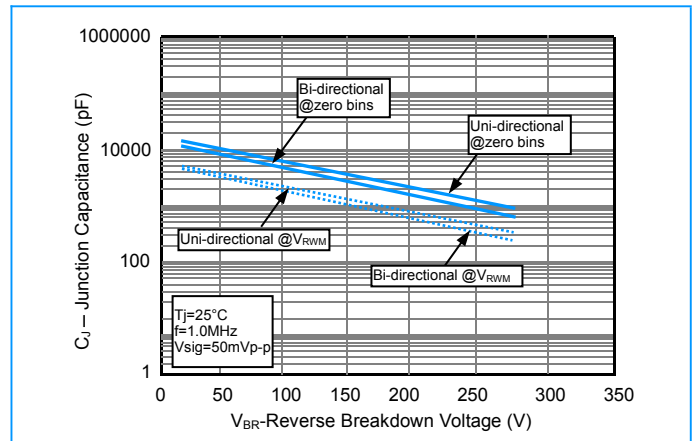

**Figure 5 - Steady State Power Derating Curve**

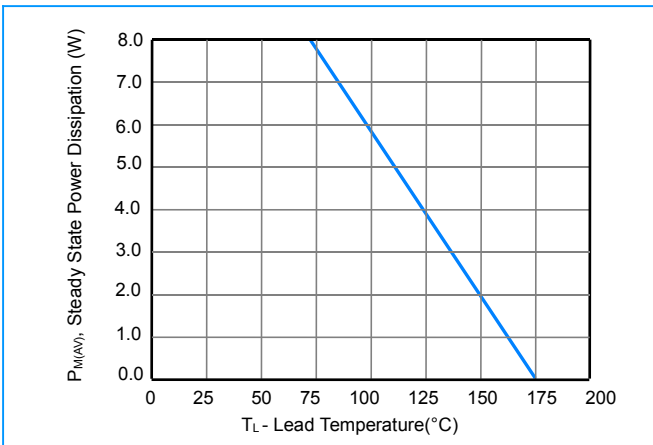

**Figure 6 - Maximum Non-Repetitive Surge Current**

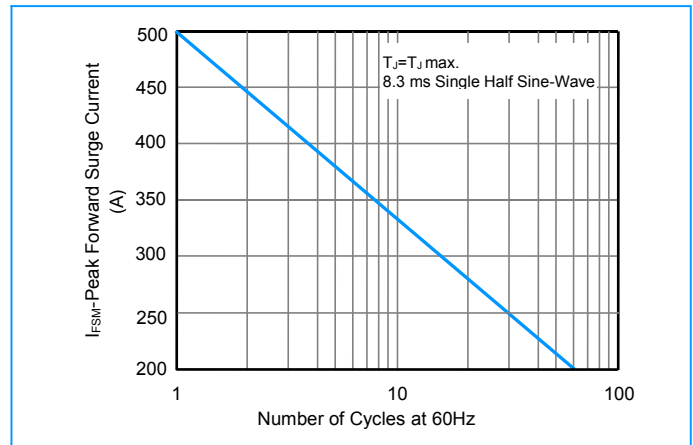

# Axial Lead Transient Voltage Suppressors (TVS)

**20KPA Series 20 To 300 V 20000W**

## I-V Curve Characteristics

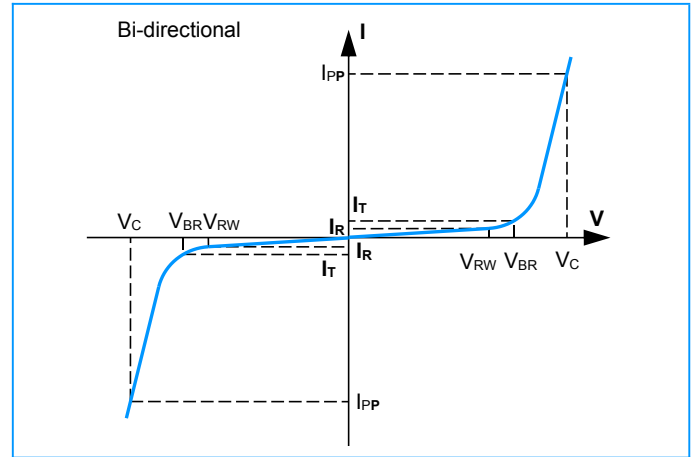
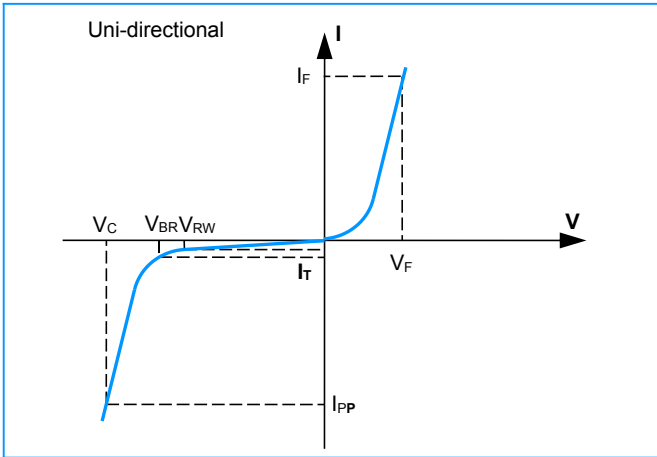

## Physical Specifications

<b>Weight</b>	0.07 ounce, 2.1gram
<b>Case</b>	JEDEC R-6/P600 Molded Plastic over glass passivated junction
<b>Polarity</b>	Color band denotes cathode except Bipolar
<b>Terminal</b>	Matte Tin-plated leads, Solderable per JESD22-B102D

## Environmental Specifications

<b>Temperature Cycle</b>	JESD22-A104
<b>Pressure Cooker</b>	JESD22-A102
<b>High Temp. Storage</b>	JESD22-A103
<b>HTRB</b>	JESD22-A108
<b>Thermal Shock</b>	JESD22-A106

## Soldering Parameters

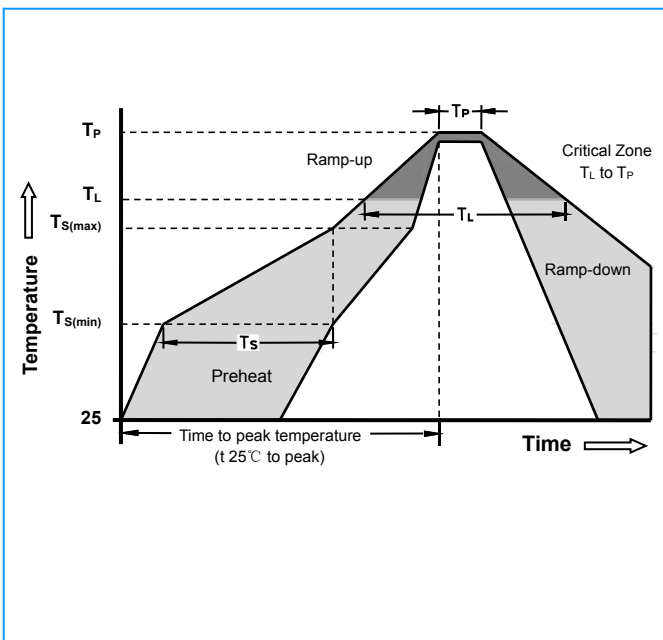

<b>Reflow Condition</b>		Lead-free assembly
<b>Pre Heat</b>	- Temperature Min ( $T_{S(min)}$ )	150°C
	- Temperature Max ( $T_{S(max)}$ )	200°C
	- Time (min to max) ( $T_S$ )	60 - 180 Seconds
<b>Average ramp up rate ( Liquidus Temp <math>T_L</math> ) to peak</b>		3°C/second max
<b><math>T_{S(max)}</math> to <math>T_L</math> - Ramp-up Rate</b>		3°C/second max
<b>Reflow</b>	- Temperature ( $T_L$ ) (Liquidus)	217°C
	- Time (min to max) ( $T_L$ )	60 - 150 Seconds
<b>Peak Temperature (<math>T_P</math>)</b>		260 +0/-5°C
<b>Time within 5°C of actual peak Temperature (<math>t_p</math>)</b>		20 - 40 Seconds
<b>Ramp-down Rate</b>		6°C/second max
<b>Time 25°C to peak Temperature (<math>T_P</math>)</b>		8 minutes Max
<b>Do not exceed</b>		280°C

# Axial Lead Transient Voltage Suppressors (TVS)

**20KPA Series 20 To 300 V 20000W**

## Dimensions

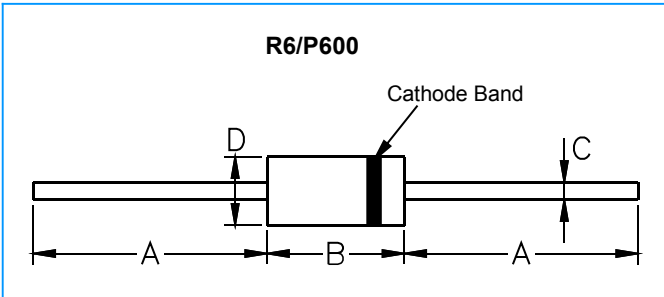

Dimensions	Inches		Millimeters	
	Min	Max	Min	Max
<b>A</b>	1.000	-	25.40	-
<b>B</b>	0.340	0.360	8.64	9.14
<b>C</b>	0.048	0.052	1.22	1.32
<b>D</b>	0.340	0.360	8.64	9.14

## Part Numbering

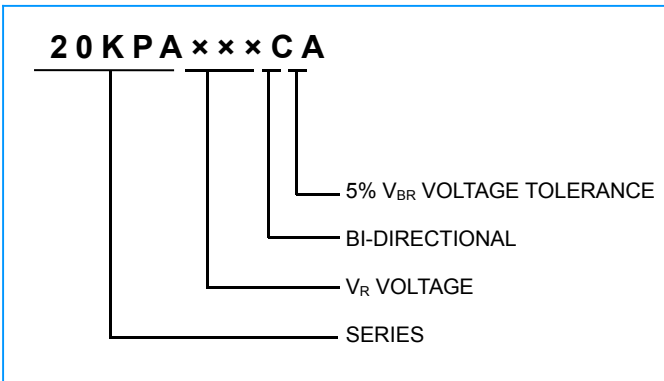

## Part Marking

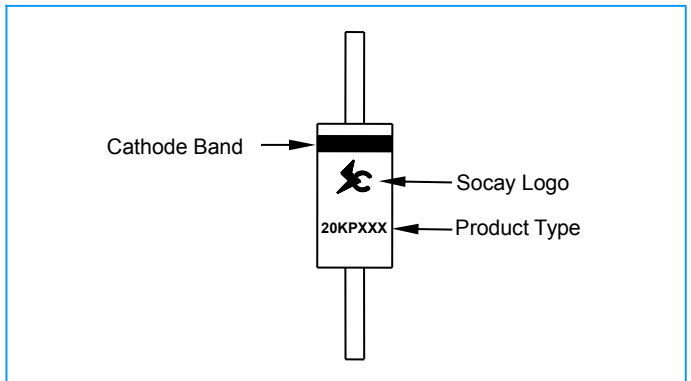

## Packaging

Part Number	Component Package	Quantity	Packaging Option
20KPAXXXXX	R6/P600	250 pcs	Box

## Packaging Dimensions Unit: Inches (Millimeters)

